

APPLICATION FOR EMPLOYMENT

PRE-EMPLOYMENT
QUESTIONNAIRE
AN EQUAL
OPPORTUNITY EMPLOYER

PERSONAL INFORMATION

NAME (LAST NAME FIRST)			SOCIAL SECURITY NO.	
PRESENT ADDRESS	APT. NO.	CITY	STATE	ZIP
PERMANENT ADDRESS	APT. NO.	CITY	STATE	ZIP
ARE YOU 18 YEARS OR OLDER? <input type="checkbox"/> YES <input type="checkbox"/> NO	PHONE			

LAST

DESIRED EMPLOYMENT

POSITION	DATE YOU CAN START	SALARY DESIRED
ARE YOU EMPLOYED NOW? <input type="checkbox"/> YES <input type="checkbox"/> NO	IF SO MAY WE INQUIRE OF YOUR PRESENT EMPLOYER? <input type="checkbox"/> YES <input type="checkbox"/> NO	
EVER APPLIED TO THIS COMPANY BEFORE? <input type="checkbox"/> YES <input type="checkbox"/> NO	WHERE?	WHEN?
EVER WORKED FOR THIS COMPANY BEFORE? <input type="checkbox"/> YES <input type="checkbox"/> NO	WHERE?	WHEN?
REASON FOR LEAVING		
NAME OF LAST SUPERVISOR AT THE COMPANY		
WHO REFERRED YOU TO THIS COMPANY?		
<input type="checkbox"/> EMPLOYMENT AGENCY	<input type="checkbox"/> NEWSPAPER ADVERTISING	<input type="checkbox"/> FRIEND
<input type="checkbox"/> STATE EMPLOYMENT OFFICE	<input type="checkbox"/> COLLEGE PLACEMENT SERVICE	<input type="checkbox"/> WALK IN <input type="checkbox"/> OTHER

FIRST

MIDDLE

EDUCATION

SCHOOL LEVEL	NAME AND LOCATION OF SCHOOL	NO. OF YEARS ATTENDED	DID YOU GRADUATE?	SUBJECTS STUDIED
GRAMMAR SCHOOL				
HIGH SCHOOL				
COLLEGE				
TRADE, BUSINESS OR CORRESPONDENCE SCHOOL				

GENERAL

SUBJECTS OF SPECIAL STUDY OR RESEARCH WORK
SPECIAL TRAINING
SPECIAL SKILLS
IF APPLYING FOR A DISMANTLER, MECHANIC OR YARD POSITION, DO YOU HAVE YOUR OWN TOOLS? <input type="checkbox"/> YES <input type="checkbox"/> NO
WHAT IS THE PRIMARY BRAND OF TOOLS OWNED?

REFERENCES

BELOW, GIVE THE NAMES OF THREE PERSONS YOU ARE NOT RELATED TO, WHOM YOU HAVE KNOWN FOR AT LEAST ONE YEAR.

1				
2				
3				

SERVICE RECORD

BRANCH OF SERVICE	DISCHARGE DATE RANK

HAVE YOU BEEN CONVICTED OF A FELONY WITHIN THE LAST 5 YEARS?	<input type="checkbox"/> YES	<input type="checkbox"/> NO
IF YES, EXPLAIN (WILL NOT NECESSARILY EXCLUDE YOU FROM CONSIDERATION)		

AUTHORIZATION

"I CERTIFY THAT THE FACTS CONTAINED IN THIS APPLICATION ARE TRUE AND COMPLETE TO THE BEST OF MY KNOWLEDGE AND UNDERSTAND THAT, IF EMPLOYED, FALSIFIED STATEMENTS ON THIS APPLICATION SHALL BE GROUNDS FOR DISMISSAL.

I AUTHORIZE INVESTIGATION OF ALL STATEMENTS CONTAINED HEREIN AND THE REFERENCES AND EMPLOYERS LISTED ABOVE TO GIVE YOU ANY AND ALL INFORMATION CONCERNING MY PREVIOUS EMPLOYMENT AND ANY PERTINENT INFORMATION THEY MAY HAVE, PERSONAL OR OTHERWISE AND RELEASE THE COMPANY FROM ALL LIABILITY FOR DAMAGE THAT MAY RESULT FROM UTILIZATION OF SUCH INFORMATION.

I ALSO UNDERSTAND AND AGREE THAT NO REPRESENTATIVE OF THE COMPANY HAS ANY AUTHORITY TO ENTER INTO ANY AGREEMENT FOR EMPLOYMENT FOR ANY SPECIFIED PERIOD OF TIME, OR TO MAKE ANY AGREEMENT CONTRARY TO THE FOREGOING, UNLESS IT IS IN WRITING AND SIGNED BY AN AUTHORIZED COMPANY REPRESENTATIVE."

DATE

SIGNATURE

FORMER EMPLOYERS

LIST BELOW LAST THREE EMPLOYERS, STARTING WITH THE MOST RECENT ONE FIRST.

NAME OF PRESENT OR LAST EMPLOYER			
ADDRESS	CITY	STATE	ZIP
STARTING DATE	LEAVING DATE	JOB TITLE	
WEEKLY STARTING SALARY	WEEKLY FINAL SALARY	MAY WE CONTACT YOUR SUPERVISOR? <input type="checkbox"/> YES <input type="checkbox"/> NO	
NAME OF SUPERVISOR	TITLE	PHONE	
DESCRIPTION OF WORK			
REASON FOR LEAVING			

NAME OF PRESENT OR LAST EMPLOYER			
ADDRESS	CITY	STATE	ZIP
STARTING DATE	LEAVING DATE	JOB TITLE	
WEEKLY STARTING SALARY	WEEKLY FINAL SALARY	MAY WE CONTACT YOUR SUPERVISOR? <input type="checkbox"/> YES <input type="checkbox"/> NO	
NAME OF SUPERVISOR	TITLE	PHONE	
DESCRIPTION OF WORK			
REASON FOR LEAVING			

NAME OF PRESENT OR LAST EMPLOYER			
ADDRESS	CITY	STATE	ZIP
STARTING DATE	LEAVING DATE	JOB TITLE	
WEEKLY STARTING SALARY	WEEKLY FINAL SALARY	MAY WE CONTACT YOUR SUPERVISOR? <input type="checkbox"/> YES <input type="checkbox"/> NO	
NAME OF SUPERVISOR	TITLE	PHONE	
DESCRIPTION OF WORK			
REASON FOR LEAVING			

PART IDENTIFICATION QUIZ

PLEASE IDENTIFY EACH OF THE FOLLOWING AUTOMOTIVE PARTS

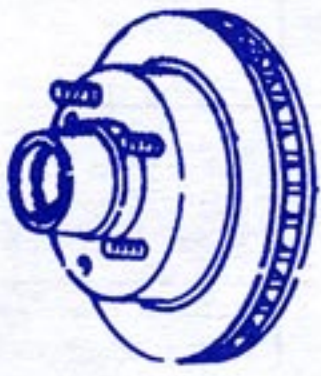

1. _____

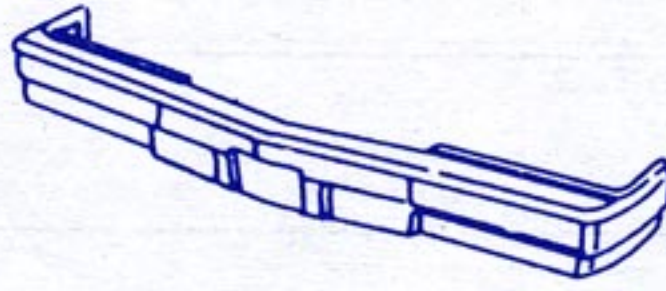

2. _____

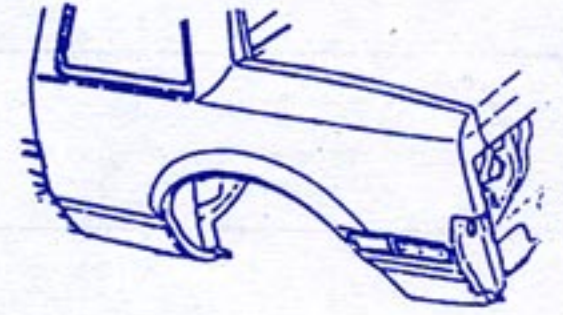

3. _____

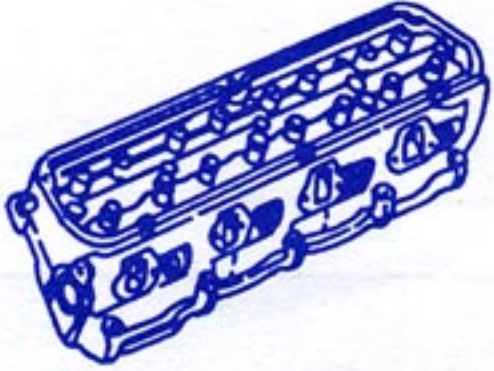

4. _____

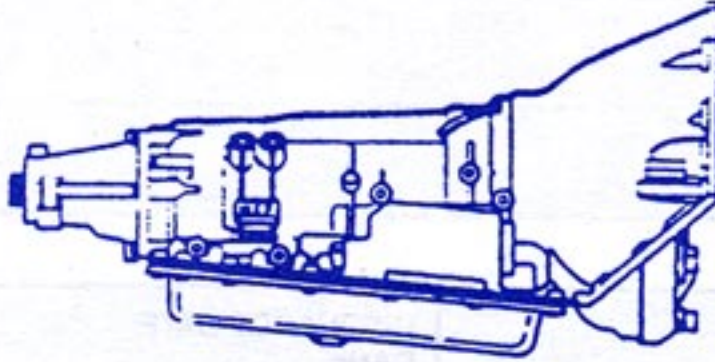

5. _____



6. _____

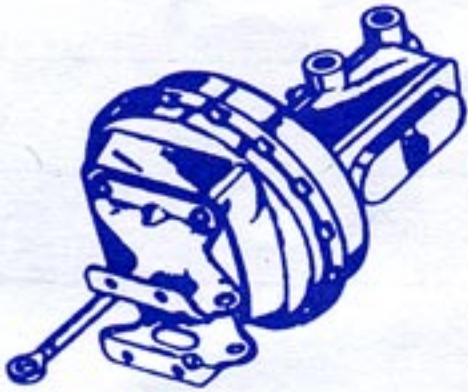

7. _____

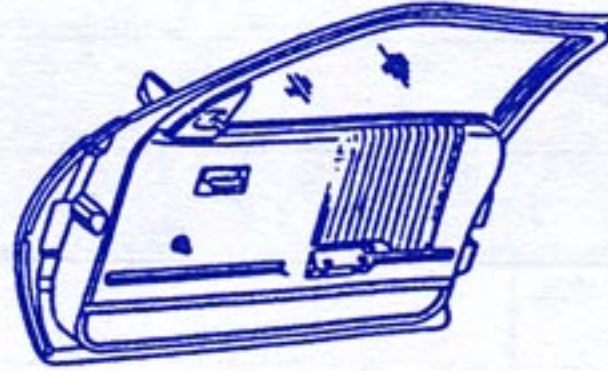

8. _____

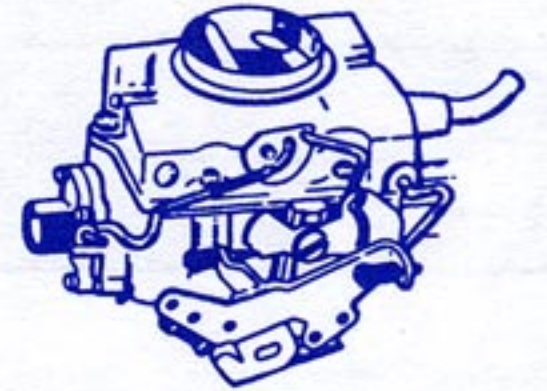

9. _____



10. _____

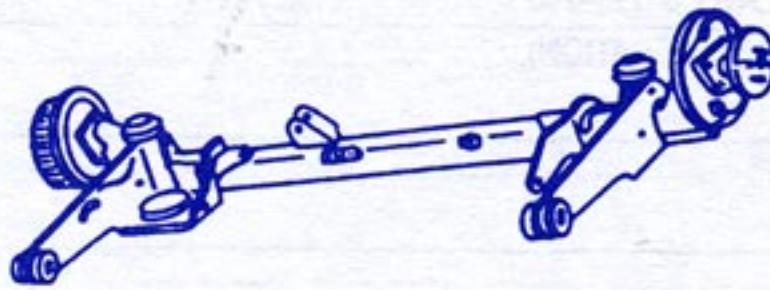

11. _____

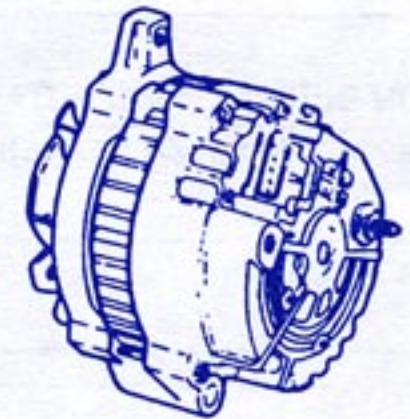

12. _____

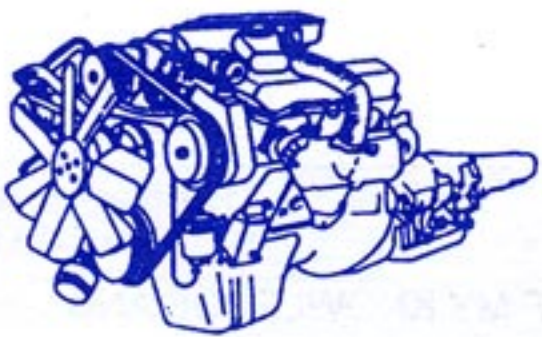

13. _____



14. _____

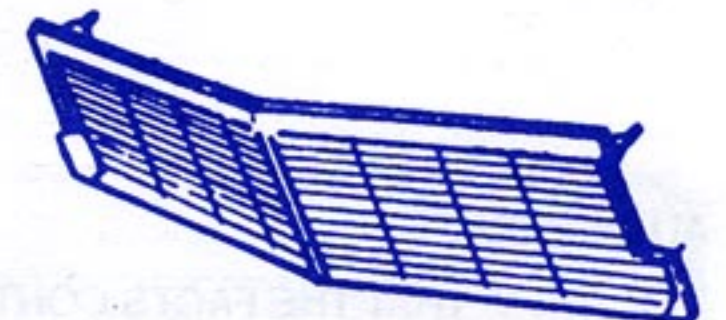

15. _____

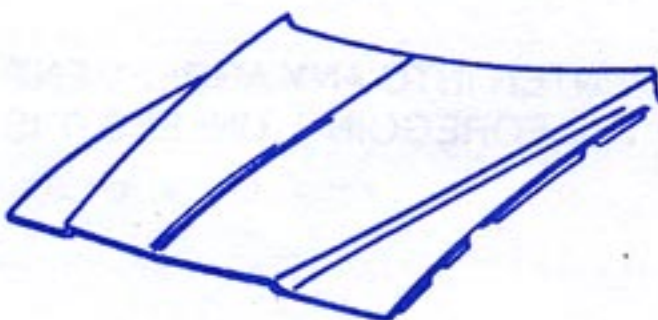

16. _____

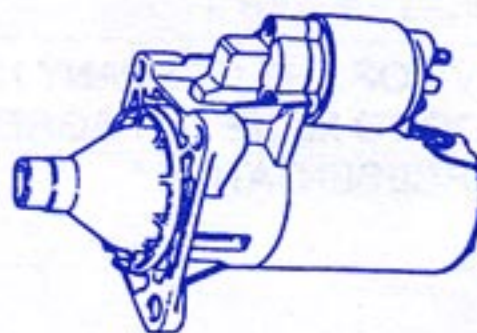

17. _____



18. _____